

# INTERMERCATO | Log Grapple Heavy Duty Series TG12 - 120S

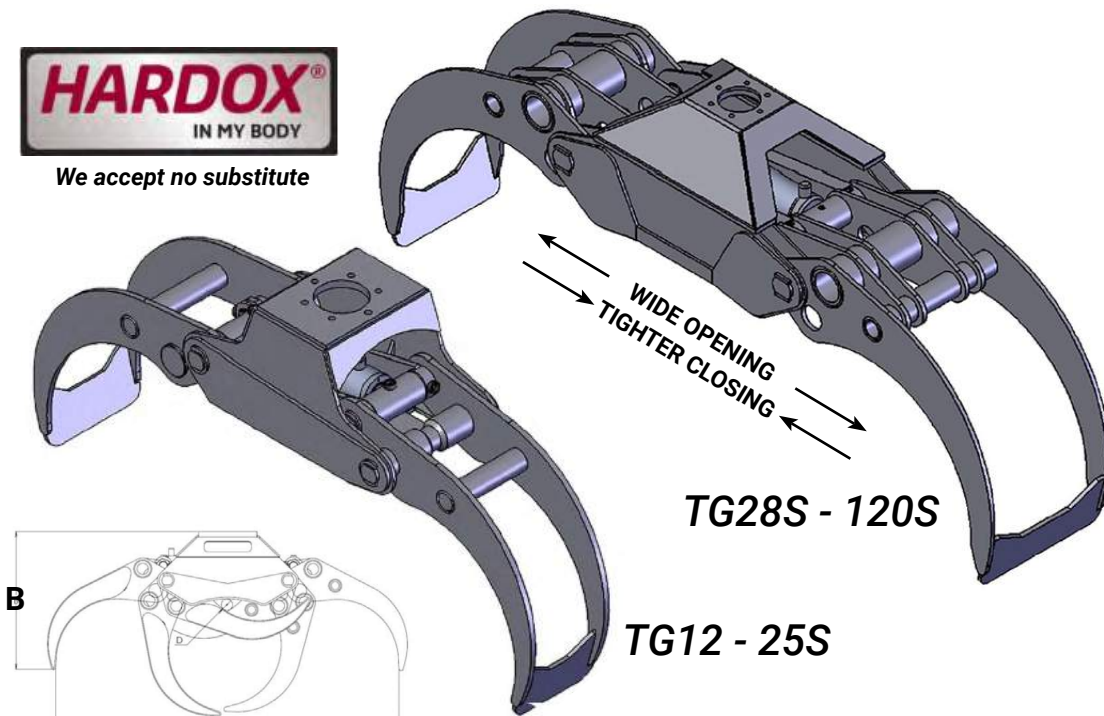











We accept no substitute



## KEY FEATURES

- Add rotator rigid mount or worm drive
- Heavy duty
- Double guide bars
- Optimized roll in/roll out properties
- High pressure cylinder with double piston rod seals
- HARDOX - high tensile wear resistant steel (400 HB)
- Extra reinforced body for rigid mounting - Excavator design

	TG 12S	TG 16S	TG16PROS	TG 22S	TG 25 S	TG25PROS	TG 28S	TG 35S	TG 42S	TG 55S	TG 80S	TG 120S
<b>A</b>	765	925	930	1310	1450	1342	1490	1870	1880	2438	2780	3115
<b>B</b>	610	573	515	576	746	723	785	808	981	1025	1176	1571
<b>C</b>	366	387	355	514	508	498	570	590	675	802	900	1029
<b>D</b>	38	60	47	90	40	72	100	65	100	150	170	180
<b>E</b>	265	301	344	321	390	482	508	522	533	633	632	1010

MODEL SPECIFICATIONS	WEIGHT  Kg	GRIP AREA  m <sup>2</sup>	PRESSURE  Bar	FLOW  l/min	CLAMPING  kN	FORESTRY  tm	CARGO  tm	CAPACITY  ton	PENDULUM  ton	RIGID  ton	FORWARDER 
TG 12S	50	0.12	200	15-30+	8	2.5	4	0.8	2.5	1.5-2	--
TG 16S	60	0.16	200	20-40	9	3	5	1	3	2-3.5	--
TG 16 PRO S	76	0.16	200	20-50	7	3	5	1	4	2-4.5	--
TG 22S	112	0.22	200	30-50	14	4	10	2	4	3-4	--
TG 25S	171	0.25	250	30-50	11	6	15	3	8	4-6	--
TG 25 PRO S	208	0.23	250	50	17	10	--	4	12	6-10	--
TG 28S	300	0.30	300	60	18	15	--	5	15	8-12	OK
TG 35S	310	0.38	300	60	22	15	--	7	15	10-12	OK
TG 42S	366	0.50	300	70	21.8	25	--	8	20	12-16	OK
TG 55S	682	0.65	300	90	22	30	--	10	30	16-22	--
TG 80S	737	0.80	300	90	22	30	--	10	25	30MH	--
TG 120S	1500	1.20	300	90	40	40	--	12	--	40MH	--

